

BUISKLEMMEN COLLIERS DE SERRAGE





INLEIDING

Ons nieuwe assortiment buisklemmen (ook wel pijpbeugels genoemd) biedt een passende en snelle oplossing voor een breed scala aan toepassingen, onafhankelijk van het type buis dat moet worden bevestigd. Of het nu gaat om een kunststof buis of een stalen leiding voor sprinklerinstallaties.

Bij Atkore Vergokan krijgen wij geregeld de vraag naar buisklemmen voor de uitbreiding van bestaande en nieuwe installaties. Daarom werd een assortiment samengesteld zodat u steeds de juiste maat terugvindt om buizen te bevestigen.

De buisklemmen zijn beschikbaar in diameters van 13 mm tot 510 mm en zijn te verkrijgen in elektrolytisch verzinkt, hot-dip en roestvast staal. Het productassortiment wordt gekenmerkt door een eenvoudige montage. Dit zorgt voor een aanzienlijke tijdswinst op de werf.

Er zijn buisklemmen zonder inleg of met EPDM inleg beschikbaar. De buisklemmen met inleg bieden dankzij de rubberen binnenlaag een betere klemming, een galvanische ontkoppeling en hebben geluiddempende eigenschappen. Daarnaast lanceren we een aantal sprinklerbeugels die voorzien zijn van FM en VdS certificaten en daardoor toegelaten zijn voor het installeren van stationaire brandblusinstallaties.

Voor buisbevestigingen in koeltechnische toepassingen werden thermische isolatieklemmen in het assortiment opgenomen. Deze bieden een speciale bescherming omdat er gemakkelijk condensatie kan op ontstaan. Zo worden verhoogd energieverlies en corrosieschade op het buissysteem vermeden.

Naast de buisklemmen zelf leveren ook alle materialen om buisklemmen te bevestigen, zoals montagerails (profielen), draadstangen, basisplaten voor draadstangen, verloopstukken en glijmoeren.

Voor meer informatie contacteer ons Sales Team VergokanSales@atkore.com of VergokanExport@atkore.com

INTRODUCTION

Notre nouvelle gamme de colliers de serrage (également appelés étriers pour tubes) offre une solution adaptée et rapide pour une large gamme d'utilisations, indépendamment du type de tuyau à fixer. Qu'il s'agisse d'un tuyau en plastique ou d'une conduite en acier pour les réseaux d'extinction par pulvérisation d'eau.

Chez Atkore Vergokan nous recevons régulièrement des demandes pour des colliers de serrage pour l'extension d'installations existantes et pour de nouvelles installations. Nous avons donc constitué une gamme qui permet au client de toujours trouver la taille adaptée lorsqu'il souhaite fixer des tuyaux.

Les colliers de serrage sont disponibles dans des diamètres de 13 à 510 mm, en acier galvanisé par électrolyse, en galvanisation à chaud ou en acier inoxydable. La gamme de produits se caractérise par un montage simple. Cela permet un gain de temps considérable sur le chantier.

Des colliers de serrage avec ou sans insert EPDM sont disponibles. Grâce à la couche intérieure en caoutchouc, les colliers de serrage avec insert offrent un meilleur serrage, une isolation galvanique et des propriétés d'insonorisation. Atkore Vergokan lance également un certain nombre d'étriers pour extincteurs par pulvérisation d'eau qui bénéficient des certificats FM et VdS, et qui peuvent donc être utilisés dans le cadre des installations fixes d'extinction.

Atkore Vergokan a intégré des pinces d'isolation thermique à sa gamme pour la fixation de tuyaux dans les applications frigorifiques. Elles offrent une protection spécifique, car de la condensation peut facilement se former. Cela permet d'éviter les pertes d'énergie accrues et les dommages dus à la corrosion au niveau du système de tuyaux. Outre les colliers de serrage, Atkore Vergokan fournit tous les matériaux pour la fixation des colliers de serrage, tels que les rails de montage (profilés), les tiges filetées, les plaques de base pour tiges filetées, les raccords de réduction et les écrous coulissants.

Pour plus d'informations, contactez notre équipe commerciale à l'adresse suivante : VergokanSales@atkore.com ou VergokanExport@atkore.com.



INHOUDSTAFEL / TABLE DES MATIÈRES

BUKDU	Buisklem DUO / Collier DUO	4
BUKDU.R	Buisklem DUO met inleg / Collier iso DUO	5
BUKEX	Buisklem EXPERT / Collier EXPERT	6
BUKEX.R	Buisklem EXPERT met inleg / Collier iso EXPERT	7
BUKTH.L2	Thermische isolatieklem L2 / Collier d'isol. therm. L2	8
BUKTH.L4	Thermische isolatieklem L4 / Collier d'isol. therm. L4	9
BUKTH.L6	Thermische isolatieklem L6 / Collier d'isol. therm. L6	10
BUKTH.R13	Thermische isolatieklem LX-13 / Collier d'isol. therm. LX-13	11
BUKTH.R19	Thermische isolatieklem LX-19 / Collier d'isol. therm. LX-19	12
BUKTH.R25	Thermische isolatieklem LX-25 / Collier d'isol. therm. LX-25	13
BUKTH.P13	Thermische isolatieklem PX-13 / Collier d'isol. therm. PX-13	14
BUKTH.P20	Thermische isolatieklem PX-20 / Collier d'isol. therm. PX-20	15
BUKTH.P30	Thermische isolatieklem PX-30 / Collier d'isol. therm. PX-30	16
BUKTH.P50	Thermische isolatieklem PX-50 / Collier d'isol. therm. PX-50	17
BULSP	Sprinkler beugel KPL / Collier pour Sprinkler KPL	18
BUKSPV	Klem voor sprinklerleiding DN-V / Collier pour sprinkler DN-F	19
BUKSPFM	Klem voor sprinklerleiding DN-F / Collier pour sprinkler DN-F	20
BUKZD	Buisklem zware last PST / Collier robuste PST	21
BUKZE	Buisklem zware last PST / Collier robuste PST	22
BUKZQ	Buisklem zware last PSF / Collier robuste PSF	23
BUKZR	Buisklem zware last PSF / Collier robuste PSF	24
XPBUKDU	Buisklem DUO / Collier DUO	25
XPBUKDU.R	Buisklem DUO met inleg / Collier iso DUO	26
BPFW	Basisplaat voor draadbuis Wirtworth BIW / Support Witworth BIW	27
BPFM	Basisplaat voor draadbuis / Support	27
BPLM	Basisplaat voor draadstang / Plaque de base à tige filetée	28
TIW	Draadstang Withworth BIW / Tige filletée Withworth BIW	28
UB	U-bout / Boulon en U	29
VRM	Verloopstuk zeskant M/V / Raccords de réduction hex M/F	30
VMM	Draadstangmoffen zeskant / Raccords de connexion hexagonales F/F	31
PNK	Glijmoer met PVC houder / Ecou coulissant avec support PVC	31
PNM	Glijmoer met metalen klemplaat / Ecou coulissant avec plaque de serrage métallique	32
I4PNK	Glijmoer met PVC houder / Ecou coulissant avec support PVC	32
I4BPLM	Basisplaat voor draadstang / Plaque de base pour tige filetée	33
I4SDBGM	Steeldeck beugel / Cintre de trapèze	33



BUKDU

Buisklem DUO / Collier DUO

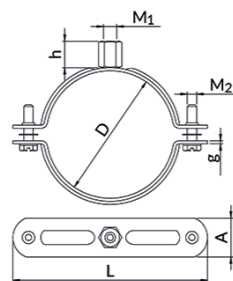
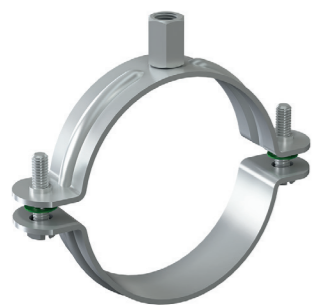

Zonder inleg.

Stand. Uitv./Exec. Std.

Te bestellen per volle verpakking.

Met anti-verlies zeskantbouten (groef en kruis).

Sans insert.

Elektrolytisch verzinkt/Electro Zingué

A commander par emballage complet.

Avec boulons hexagonaux anti-perte (rainure et croix).

HD	Artikel Référence	L mm	A mm	g	↔	kg/st kg/ pc	D mm	Max. bel. kN Max. char. kN	M1	h mm	Con. type con.	Stock	Eenh. Unité
-	BUKDU.015	58	20	1,25		0,040	15-17	0.8	M8/M10	17	D	100	st/pc
-	BUKDU.018	62	20	1,25		0,042	18-22	0.8	M8/M10	17	D	100	X st/pc
-	BUKDU.023	66	20	1,25		0,046	23-27	0.8	M8/M10	17	D	100	X st/pc
-	BUKDU.028	70	20	1,25		0,048	28-32	0.8	M8/M10	17	D	100	st/pc
-	BUKDU.033	76	20	1,25		0,052	33-37	0.8	M8/M10	17	D	100	X st/pc
-	BUKDU.039	83	20	1,25		0,056	39-44	0.8	M8/M10	17	D	50	st/pc
-	BUKDU.045	88	20	1,25		0,059	45-49	0.8	M8/M10	17	D	50	X st/pc
-	BUKDU.050	93	20	1,25		0,059	50-54	0.8	M8/M10	17	D	50	st/pc
-	BUKDU.056	103	20	1,25		0,066	56-59	0.8	M8/M10	17	D	50	st/pc
-	BUKDU.060	105	20	1,25		0,068	60-65	0.8	M8/M10	17	D	50	st/pc
-	BUKDU.066	116	20	1,50		0,088	66-71	0.8	M8/M10	17	D	50	st/pc
-	BUKDU.072	118	20	1,50		0,089	72-78	1.4	M8/M10	17	D	25	st/pc
-	BUKDU.079	125	20	1,80		0,106	79-84	1.4	M8/M10	17	D	25	st/pc
-	BUKDU.085	132	20	1,80		0,113	85-91	1.4	M8/M10	17	D	25	st/pc
-	BUKDU.092	139	25	2,00		0,153	92-98	1.4	M8/M10	17	D	25	st/pc
-	BUKDU.099	146	25	2,00		0,166	99-105	1.4	M8/M10	17	D	25	st/pc
-	BUKDU.106	154	25	2,00		0,174	106-113	1.4	M8/M10	17	D	25	X st/pc
-	BUKDU.114	162	25	2,00		0,183	114-122	1.8	M8/M10	17	D	25	st/pc
-	BUKDU.123	171	25	2,00		0,197	123-131	1.8	M8/M10	17	D	25	st/pc
-	BUKDU.132	180	25	2,00		0,206	132-140	1.8	M8/M10	17	D	25	st/pc
-	BUKDU.141	191	25	2,50		0,255	141-148	2.1	M8/M10	17	D	20	st/pc
-	BUKDU.149	200	25	2,50		0,280	149-157	2.1	M8/M10	17	D	10	st/pc
-	BUKDU.158	209	25	2,50		0,284	158-167	2.1	M8/M10	17	D	10	st/pc
-	BUKDU.168	218	25	2,50		0,302	168-177	2.1	M8/M10	17	D	10	st/pc



BUKDU.R

Buisklem DUO met inleg / Collier iso DUO

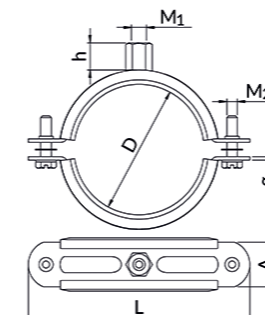

Met EPDM inleg.

Stand. Uitv./Exec. Std.

Te bestellen per volle verpakking.

Met anti-verlies zeskantbouten (groef en kruis)
Temperatuurbereik: -40/+120 °C.
Geluidsisolerend volgens DIN 4109.

Avec insert EPDM.

Elektrolytisch verzinkt/Electro Zingué

A commander par emballage complet.

Avec boulons hexagonaux anti-perte (rainure et croix)
Plage de température : -40/+120 °C
Isolation acoustique selon DIN 4109

HD	Artikel Référence	L mm	A mm	g	↔	kg/st kg/ pc	D mm	Max. bel. kN Max. char. kN	M1	h mm	Con. type con.	Stock	Eenh. Unité
-	BUKDU.010R	58	20	1,25		0,050	10-12	0.8	M8/M10	17	D	100	st/pc
-	BUKDU.013R	62	20	1,25		0,052	13-16	0.8	M8/M10	17	D	100	st/pc
-	BUKDU.017R	66	20	1,25		0,053	17-20	0.8	M8/M10	17	D	100	st/pc
-	BUKDU.020R	70	20	1,25		0,060	21-25	0.8	M8/M10	17	D	100	X st/pc
-	BUKDU.026R	76	20	1,25		0,065	26-30	0.8	M8/M10	17	D	100	X st/pc
-	BUKDU.031R	83	20	1,25		0,075	31-36	0.8	M8/M10	17	D	100	X st/pc
-	BUKDU.036R	88	20	1,25		0,077	36-41	0.8	M8/M10	17	D	100	st/pc
-	BUKDU.041R	93	20	1,25		0,085	41-46	0.8	M8/M10	17	D	50	st/pc
-	BUKDU.046R	103	20	1,25		0,089	46-52	0.8	M8/M10	17	D	50	X st/pc
-	BUKDU.053R	105	20	1,25		0,083	53-58	0.8	M8/M10	17	D	50	st/pc
-	BUKDU.059R	116	20	1,50		0,104	59-64	0.8	M8/M10	17	D	50	st/pc
-	BUKDU.065R	118	20	1,50		0,165	65-71	1.4	M8/M10	17	D	25	st/pc
-	BUKDU.072R	125	20	1,80		0,176	72-78	1.4	M8/M10	17	D	25	st/pc
-	BUKDU.079R	132	20	1,80		0,188	79-85	1.4	M8/M10	17	D	25	st/pc
-	BUKDU.086R	139	25	2,00		0,202	86-92	1.4	M8/M10	17	D	25	st/pc
-	BUKDU.093R	146	25	2,00		0,214	93-99	1.4	M8/M10	17	D	25	st/pc
-	BUKDU.100R	154	25	2,00		0,223	100-107	1.4	M8/M10	17	D	25	st/pc
-	BUKDU.108R	162	25	2,00		0,247	108-115	1.8	M8/M10	17	D	25	X st/pc
-	BUKDU.116R	171	25	2,00		0,259	116-124	1.8	M8/M10	17	D	25	st/pc
-	BUKDU.125R	180	25	2,00		0,265	125-133	1.8	M8/M10	17	D	25	st/pc
-	BUKDU.133R	191	25	2,50		0,326	133-141	2.1	M8/M10	17	D	20	st/pc
-	BUKDU.142R	200	25	2,50		0,346	142-150	2.1	M8/M10	17	D	25	st/pc
-	BUKDU.151R	209	25	2,50		0,357	151-160	2.1	M8/M10	17	D	20	st/pc
-	BUKDU.160R	218	25	2,50		0,376	160-169	2.1	M8/M10	17	D	20	st/pc



BUKEX

Buisklem EXPERT / Collier EXPERT

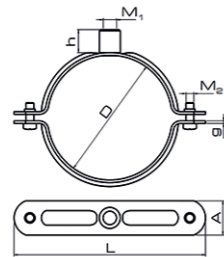

Zonder inleg.	Sans insert.
Stand. Uitv./Exec. Std.	Elektrolytisch verzinkt/Electro Zingué
Te bestellen per volle verpakking.	A commander par emballage complet.
Met kruiskopbouten (tot 130), met zeskantbout (>130).	Avec boulons à tête Phillips (jusqu'à 130), avec boulon hexagonal (> 130).

HD	Artikel Référence	L mm	A mm	g mm	↔	kg/st kg/pc	D mm	Max. bel. kN Max. char. kN	M1	h mm	Con. type Type con.	Stock	Eenh. Unité
-	BUKEX.010	35	15	1,50		0,020	10-11	2	M6	4	A	100	st/pc
-	BUKEX.016	47	14	1,50		0,020	16-18	2	M6	4	A	100	st/pc
-	BUKEX.021	63	20	2,00		0,040	21-23	2	M8	5.3	A	100	X st/pc
-	BUKEX.026	70	20	2,00		0,050	26-29	2	M8	5.3	A	100	X st/pc
-	BUKEX.033	75	20	2,00		0,060	33-36	2	M8	5.3	A	100	X st/pc
-	BUKEX.041	90	24	2,00		0,080	41-45	2	M8	5.3	A	50	X st/pc
-	BUKEX.048	100	24	2,00		0,090	48-52	2	M8	5.3	A	50	X st/pc
-	BUKEX.059	110	24	2,00		0,110	59-63	2	M8	5.3	A	50	st/pc
-	BUKEX.075	130	26	2,50		0,180	75-80	2.4	M10/M12	17.5	B	25	X st/pc
-	BUKEX.087	149	26	2,50		0,210	87-92	2.4	M10/M12	17.5	B	25	X st/pc
-	BUKEX.099	155	26	2,50		0,220	99-104	2.4	M10/M12	17.5	B	25	st/pc
-	BUKEX.109	170	26	2,50		0,240	109-114	2.4	M10/M12	17.5	B	25	X st/pc
-	BUKEX.114	167	26	2,50		0,240	114-120	2.4	M10/M12	17.5	B	25	st/pc
-	BUKEX.119	176	26	2,50		0,260	119-125	2.4	M10/M12	17.5	B	25	st/pc
-	BUKEX.123	183	26	2,50		0,270	123-130	2.4	M10/M12	17.5	B	25	st/pc
-	BUKEX.131	194	26	2,50		0,280	131-138	2.4	M10/M12	17.5	B	25	st/pc
-	BUKEX.146	220	35	3,00		0,540	145-155	3.9	M10/M12	25	C	10	st/pc
-	BUKEX.160	235	35	3,00		0,550	160-169	3.9	M10/M12	25	C	10	X st/pc
-	BUKEX.169	236	35	3,00		0,580	169-178	3.9	M10/M12	25	C	10	st/pc
-	BUKEX.197	284	35	3,00		0,700	197-206	3.9	M10/M12	25	C	10	st/pc
-	BUKEX.219	305	35	3,00		0,750	219-228	3.9	M12/M16	25	C	10	st/pc
-	BUKEX.249	334	35	3,00		0,840	249-258	3.9	M12/M16	25	C	10	st/pc
-	BUKEX.269	376	35	4,00		1,280	264-273	4.5	M12/M16	26	C	5	st/pc
-	BUKEX.312	420	35	4,00		1,420	307-316	4.5	M12/M16	26	C	5	st/pc
-	BUKEX.322	428	35	4,00		1,470	317-326	4.5	M12/M16	26	C	5	st/pc
-	BUKEX.347	423	35	4,00		1,470	345-357	4.5	M12/M16	26	C	5	st/pc
-	BUKEX.400	467	35	4,00		1,600	400-410	4.5	M12/M16	26	C	5	st/pc
-	BUKEX.500	569	35	4,00		1,970	500-510	4.5	M12/M16	26	C	5	st/pc



BUKEX.R

Buisklem EXPERT met inleg / Collier iso EXPERT

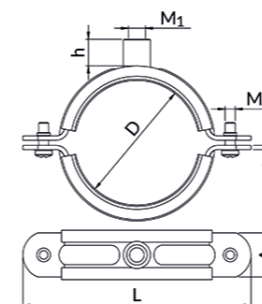

Met EPDM inleg	Avec insert EPDM
Stand. Uitv./Exec. Std.	Elektrolytisch verzinkt/Electro Zingué
Te bestellen per volle verpakking.	A commander par emballage complet.
Met kruiskopbouten (tot 130), met zeskantbout (>130). Temperatuurbereik: -40/+120°C Silicone inleg voor temperatuurbereik -60/+250°C verkrijgbaar op aanvraag. Geluidsisolerend volgens DIN 4109	Avec boulons à tête Phillips (jusqu'à 130), avec boulon hexagonal (> 130) Plage de température : -40/+120 °C Insert en silicone pour plage de température -60/+250 °C disponible sur demande. Isolation acoustique selon DIN 4109

HD	Artikel Référence	L mm	A mm	g mm	↔	kg/st kg/pc	D mm	Max. bel. kN Max. char. kN	M1	h mm	Con. type Type con.	Stock	Eenh. Unité
-	BUKEX.016R	63	20	2,00		0,060	16-20	2	M8	5.3	A	100	st/pc
HD	BUKEX.020R	70	20	2,00		0,060	20-24	2	M8	5.3	A	100	X st/pc
HD	BUKEX.026R	75	20	2,00		0,070	26-30	2	M8	5.3	A	100	st/pc
HD	BUKEX.034R	90	24	2,00		0,100	34-39	2	M8	5.3	A	50	X st/pc
HD	BUKEX.041R	100	24	2,00		0,110	41-46	2	M8	5.3	A	50	X st/pc
HD	BUKEX.048R	101	24	2,00		0,120	48-53	2	M8	5.3	A	50	X st/pc
HD	BUKEX.052R	110	24	2,00		0,130	52-57	2	M8	5.3	A	50	st/pc
HD	BUKEX.059R	115	24	2,00		0,130	59-64	2	M8	5.3	A	50	st/pc
HD	BUKEX.074R	136	26	2,50		0,220	74-79	2.4	M10/M12	17.5	B	25	X st/pc
-	BUKEX.078R	149	26	2,50		0,250	78-84	2.4	M10/M12	17.5	B	25	st/pc
HD	BUKEX.085R	154	26	2,50		0,260	85-91	2.4	M10/M12	17.5	B	25	st/pc
-	BUKEX.102R	170	26	2,50		0,280	102-108	2.4	M10/M12	17.5	B	25	st/pc
HD	BUKEX.107R	176	26	2,50		0,284	107-113	2.4	M10/M12	17.5	B	25	X st/pc
HD	BUKEX.112R	176	26	2,50		0,310	112-118	2.4	M10/M12	17.5	B	25	st/pc
-	BUKEX.124R	194	26	2,50		0,340	124-131	2.4	M10/M12	17.5	B	25	st/pc
HD	BUKEX.130R	194	26	2,50		0,350	130-138	2.4	M10/M12	17.5	B	20	st/pc
HD	BUKEX.141R	221	35	3,00		0,610	141-148	3.9	M10/M12	25	C	10	st/pc
HD	BUKEX.158R	235	35	3,00		0,630	158-166	3.9	M10/M12	25	C	10	X st/pc
HD	BUKEX.164R	236	35	3,00		0,650	164-172	3.9	M10/M12	25	C	10	st/pc
HD	BUKEX.200R	286	35	3,00		0,820	200-208	3.9	M10/M12	25	C	10	st/pc
-	BUKEX.210R	300	35	3,00		0,850	206-214	3.9	M12/M16	25	C	10	st/pc
HD	BUKEX.214R	305	35	3,00		0,870	214-222	3.9	M12/M16	25	C	5	st/pc
HD	BUKEX.244R	334	35	3,00		0,940	244-252	3.9	M12/M16	25	C	10	st/pc
HD	BUKEX.264R	376	35	4,00		1,420	264-273	4.5	M12/M16	26	C	5	st/pc
-	BUKEX.307R	420	35	4,00		1,580	307-316	4.5	M12/M16	26	C	5	st/pc
-	BUKEX.317R	428	35	4,00		1,620	317-326	4.5	M12/M16	26	C	5	st/pc
-	BUKEX.355R	423	35	4,00		1,592	345-357	4.5	M12/M16	26	C	5	st/pc
-	BUKEX.395R	467	35	4,00		1,840	395-404	4.5	M12/M16	26	C	5	st/pc
-	BUKEX.495R	569	35	4,00		2,220	495-504	4.5	M12/M16	26	C	5	st/pc



BUKTH.R19

Thermische isolatieklem LX-19 / Collier d'isol. therm. LX-19

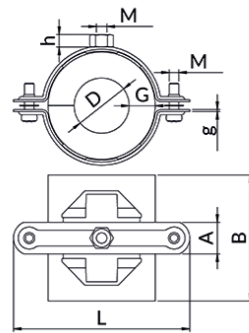

Thermal cond. Coëff. 0,036W/m.K
Stand. Uitv./Exec. Std.

Met kruiskopbouten M6
Temperatuurbereik: +0/+110 °C

Isolatiemateriaal: Dikte: 19 mm.

Plastic verlijmd met rubber.
Vrij van CFK's.

Cond. thermique Coeff. 0,036W/m.K
Elektrolytisch verzinkt/Electro Zingué

Avec boulon à tête Phillips M6.
Plage de température : +0/+110 °C

Matériau isolant : Épaisseur : 19 mm.

Plastique collé avec du caoutchouc.
Exempt de CFC.

HD	Artikel Référence	L mm	A mm	g mm	↔	kg/st kg/ pc	D mm	Max. bel. kN Max. char. kN	M1	h mm	Con. type con.	Iso. d. G Ép. G	Iso. L B Lo. B	Stock	Eenh. Unité
-	BUKTH.010R19	100	24	1,50		0,110	10.2	0.8	M8	5.3	D	19	80	1	st/pc
-	BUKTH.012R19	100	24	1,50		0,110	12	0.8	M8	5.3	D	19	80	1	st/pc
-	BUKTH.015R19	100	24	1,50		0,120	15	0.8	M8	5.3	D	19	80	1	st/pc
-	BUKTH.018R19	102	24	1,50		0,130	18	0.8	M8	5.3	D	19	80	1	st/pc
-	BUKTH.022R19	110	24	1,50		0,130	22	0.8	M8	5.3	D	19	80	1	st/pc
-	BUKTH.025R19	113	24	1,50		0,150	25	0.8	M8	5.3	D	19	80	1	st/pc
-	BUKTH.028R19	113	24	1,50		0,150	28	0.8	M8	5.3	D	19	80	1	st/pc
-	BUKTH.030R19	113	24	1,50		0,150	30	0.8	M8	5.3	D	19	80	1	st/pc
-	BUKTH.035R19	128	26	2,00		0,200	35	0.8	M8	10.1	D	19	80	1	st/pc
-	BUKTH.042R19	133	26	2,00		0,240	42.4	1.4	M8	10.1	D	19	92	1	st/pc
-	BUKTH.048R19	150	26	2,00		0,240	48.3	1.4	M8	10.1	D	19	92	1	st/pc
-	BUKTH.054R19	146	26	2,00		0,260	54	1.4	M8	10.1	D	19	92	1	st/pc
-	BUKTH.060R19	155	26	2,50		0,290	60.3	1.4	M8	17.5	D	19	92	1	st/pc
-	BUKTH.064R19	155	26	2,50		0,290	64	1.4	M8	17.5	D	19	92	1	st/pc
-	BUKTH.070R19	167	26	2,00		0,290	70	1.8	M8	10.1	D	19	92	1	st/pc
-	BUKTH.076R19	165	26	2,00		0,320	76.1	1.8	M8	10.1	D	19	92	1	st/pc
-	BUKTH.089R19	194	26	2,50		0,390	88.9	1.8	M8	17.5	D	19	92	1	st/pc



BUKTH.R25

Thermische isolatieklem LX-25 / Collier d'isol. therm. LX-25

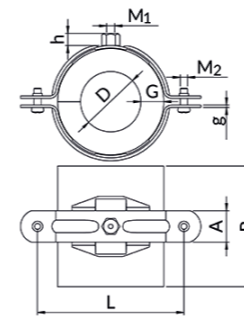

Thermal cond. Coëff. 0,038W/m.K
Stand. Uitv./Exec. Std.

Met kruiskopbouten M6
Temperatuurbereik: +0/+110 °C

Isolatiemateriaal: Dikte: 25 mm.

Plastic verlijmd met rubber.
Vrij van CFK's.

Cond. thermique Coeff. 0,038W/m.K
Elektrolytisch verzinkt/Electro Zingué

Avec boulon à tête Phillips M6.
Plage de température : +0/+110 °C

Matériau isolant : Épaisseur : 25 mm.

Plastique collé avec du caoutchouc.
Exempt de CFC.

HD	Artikel Référence	L mm	A mm	g mm	↔	kg/st kg/ pc	D mm	Max. bel. kN Max. char. kN	M1	h mm	Con. type con.	Iso. d. G Ép. G	Iso. L B Lo. B	Stock	Eenh. Unité
-	BUKTH.015R25	113	24	1,50		0,160	15	0.8	M8	5.3	A	25	100	1	st/pc
-	BUKTH.018R25	113	24	1,50		0,160	18	0.8	M8	5.3	A	25	100	1	st/pc
-	BUKTH.022R25	128	26	2,00		0,210	22	0.8	M8	10.1	B	25	100	1	st/pc
-	BUKTH.025R25	128	26	2,00		0,220	25	1.4	M8	10.1	B	25	100	1	st/pc
-	BUKTH.028R25	133	26	2,00		0,240	28	1.4	M8	10.1	B	25	100	1	st/pc
-	BUKTH.035R25	150	26	2,00		0,240	35	1.4	M8	10.1	B	25	100	1	st/pc
-	BUKTH.042R25	146	26	2,00		0,290	42.4	1.4	M8	10.1	B	25	115	1	st/pc
-	BUKTH.048R25	155	26	2,50		0,310	48.3	1.4	M8	17.5	B	25	115	1	st/pc
-	BUKTH.054R25	155	26	2,50		0,310	54	1.4	M8	10.1	B	25	115	1	st/pc
-	BUKTH.060R25	167	26	2,00		0,320	60.3	1.8	M8	10.1	B	25	115	1	st/pc
-	BUKTH.064R25	165	26	2,00		0,350	64	1.8	M8	10.1	B	25	115	1	st/pc
-	BUKTH.070R25	176	26	2,50		0,380	70	1.8	M8	17.5	B	25	115	1	st/pc
-	BUKTH.076R25	183	26	2,50		0,400	76.1	1.8	M8	17.5	B	25	115	1	st/pc
-	BUKTH.089R25	194	26	2,50		0,450	88.9	1.8	M8	17.5	B	25	115	1	st/pc



BUKTH.P13

Thermische isolatieklem PX-13 / Collier d'isol. therm. PX-13

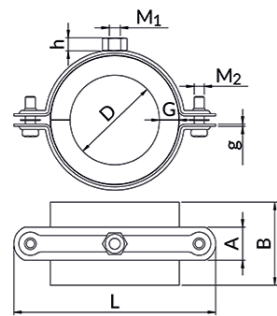

Thermal cond. Coëff. 0,044W/m.K

Stand. Uitv./Exec. Std.

Met kruiskopbouten M6 (tot 114), met zeskantbout M8 (vanaf 133)

Temperatuurbereik: -50/+105°C
Isolatiemateriaal: Dikte: 13mm.

PUR schuim (80kg/m³). Extra buitenschil van akoestische film.

Cond. thermique Coeff. 0,044W/m.K

Elektrolytisch verzinkt/Electro Zingué

Avec boulons à tête Phillips M6 (jusqu'à 114), avec boulon hexagonal M8 (à partir de 133)

Plage de température : -50/+105 °C
Matériau isolant : Épaisseur : 13 mm.

Mousse PUR (80 kg/m³). Enveloppe extérieure supplémentaire du film acoustique.

HD	Artikel Référence	L mm	A mm	g mm	↔	kg/st kg/pc	D mm	Max. bel. kN Max. char. kN	M1	h mm	Con. type Type con.	Iso. d. G Iso. Ép. G	Iso. L B Iso. Lo. B	Stock	Eenh. Unité
-	BUKTH.010P13	70	20	1,25		0,080	10,2	0,8	M8/M10	17,0	D	13	50	1	st/pc
-	BUKTH.012P13	76	20	1,25		0,070	12	0,8	M8/M10	17,0	D	13	50	1	st/pc
-	BUKTH.015P13	90	24	2,00		0,290	15	0,8	M8	5,3	A	13	50	1	st/pc
-	BUKTH.018P13	90	24	2,00		0,300	18	0,8	M8	5,3	A	13	50	1	st/pc
-	BUKTH.022P13	100	24	2,00		0,320	22	0,8	M8	5,3	A	13	50	1	st/pc
-	BUKTH.028P13	101	24	2,00		0,360	28	0,8	M8	5,3	A	13	50	1	st/pc
-	BUKTH.035P13	110	24	2,00		0,460	35	0,8	M8	5,3	A	13	50	1	st/pc
-	BUKTH.042P13	115	24	2,00		0,500	42,4	0,8	M8	5,3	A	13	50	1	st/pc
-	BUKTH.048P13	130	26	2,50		0,550	48,3	1,4	M8	17,5	B	13	50	1	st/pc
-	BUKTH.054P13	130	26	2,50		0,580	54	1,4	M8	17,5	B	13	50	1	st/pc
-	BUKTH.060P13	149	26	2,50		0,620	60,3	1,4	M8	17,5	B	13	50	1	st/pc
-	BUKTH.064P13	149	26	2,50		0,640	64	1,4	M8	17,5	B	13	50	1	st/pc
-	BUKTH.076P13	155	26	2,50		0,720	76,1	1,4	M8/M10	17,5	B	13	75	1	st/pc
-	BUKTH.089P13	167	26	2,50		0,820	88,9	1,8	M8	17,5	B	13	75	1	st/pc
-	BUKTH.108P13	194	26	2,50		1,180	108	1,8	M8	17,5	B	13	75	1	st/pc
-	BUKTH.114P13	194	26	2,50		1,210	114,3	1,8	M8	17,5	B	13	75	1	st/pc
-	BUKTH.133P13	235	35	3,00		1,350	133	2,1	M8/M10	25,0	C	13	100	1	st/pc
-	BUKTH.140P13	235	35	3,00		1,380	139,7	2,1	M8/M10	25,0	C	13	100	1	st/pc



BUKTH.P20

Thermische isolatieklem PX-20 / Collier d'isol. therm. PX-20

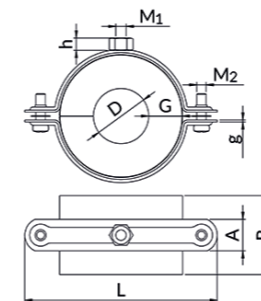
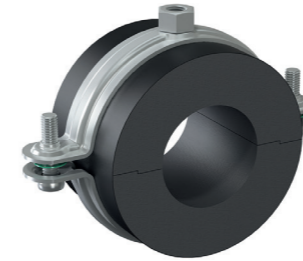

Thermal cond. Coëff. 0,044W/m.K

Stand. Uitv./Exec. Std.

Met kruiskopbouten M6 (tot 089), met zeskantbout M8 (vanaf 108)
Temperatuurbereik: -50/+105°C
Isolatiemateriaal: Dikte: 20mm.

PUR schuim (80kg/m³). Extra buitenschil van akoestische film.

Cond. thermique Coeff. 0,044W/m.K

Elektrolytisch verzinkt/Electro Zingué

Avec boulons à tête Phillips M6 (jusqu'à 089), avec boulon hexagonal M8 (à partir de 108)
Plage de température : -50/+105 °C
Matériau isolant : Épaisseur : 20 mm.

Mousse PUR (80 kg/m³). Enveloppe extérieure supplémentaire du film acoustique

HD	Artikel Référence	L mm	A mm	g mm	↔	kg/st kg/pc	D mm	Max. bel. kN Max. char. kN	M1	h mm	Con. type Type con.	Iso. d. G Iso. Ép. G	Iso. L B Iso. Lo. B	Stock	Eenh. Unité
-	BUKTH.015P20	101	24	2,00		0,290	15	0,8	M8	5,3	A	20	50	1	st/pc
-	BUKTH.018P20	101	24	2,00		0,300	18	0,8	M8	5,3	A	20	50	1	st/pc
-	BUKTH.022P20	110	24	2,00		0,320	22	0,8	M8	5,3	A	20	50	1	st/pc
-	BUKTH.028P20	115	24	2,00		0,360	28	0,8	M8	5,3	A	20	50	1	st/pc
-	BUKTH.035P20	130	26	2,50		0,460	35	1,4	M8	17,5	B	20	50	1	st/pc
-	BUKTH.042P20	136	26	2,50		0,500	42,4	1,4	M8	17,5	B	20	50	1	st/pc
-	BUKTH.048P20	149	26	2,50		0,550	48,3	1,4	M8	17,5	B	20	50	1	st/pc
-	BUKTH.054P20	145	26	2,50		0,580	54	1,4	M8	17,5	B	20	50	1	st/pc
-	BUKTH.057P20	145	26	2,50		0,600	57	1,4	M8	17,5	B	20	50	1	st/pc
-	BUKTH.060P20	155	26	2,50		0,620	60,3	1,4	M8	17,5	B	20	50	1	st/pc
-	BUKTH.064P20	155	26	2,50		0,640	64	2,2	M8/M10	17,5	B	20	50	1	st/pc
-	BUKTH.076P20	167	26	2,50		0,720	76,1	1,8	M8	17,5	B	20	75	1	st/pc
-	BUKTH.089P20	183	26	2,50		0,820	88,9	2,2	M8/M10	17,5	B	20	75	1	st/pc
-	BUKTH.108P20	220	35	3,00		1,180	108	2,1	M8/M10	25,0	C	20	75	1	st/pc
-	BUKTH.114P20	220	35	3,00		1,210	114,3	2,2	M8/M10	25,0	C	20	75	1	st/pc
-	BUKTH.133P20	236	35	3,00		1,350	133	2,1	M8/M10	25,0	C	20	100	1	st/pc
-	BUKTH.140P20	236	35	3,00		1,380	139,7	3,9	M10/M12	25,0	C	20	100	1	st/pc
-	BUKTH.159P20	284	35	3,00		1,600	159	3,9	M10/M12	25,0	C	20	100	1	st/pc
-	BUKTH.168P20	286	35	3,00		1,690	168,3	3,9	M10/M12	25,0	C	20	100	1	st/pc



BUKTH.P30

Thermische isolatieklem PX-30 / Collier d'isol. therm. PX-30

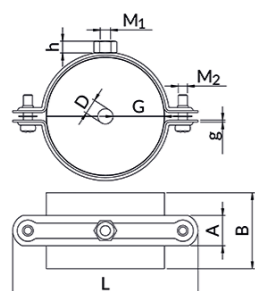
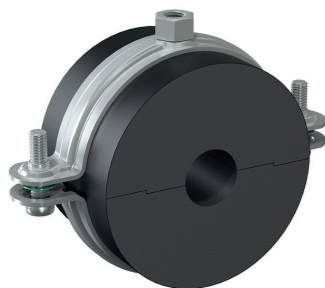

Thermal cond. Coëff. 0,044W/m.K
Stand. Uitv./Exec. Std.

Met kruiskopbouten M6 (tot 076), met zeskantbout M8 (vanaf 089), M12 (vanaf 219)
Temperatuurbereik: -50/+105 °C
Isolatiemateriaal: Dikte: 30mm.

PUR schuim (80kg/m³). Extra buitenschil van akoestische film.

Cond. thermique Coeff. 0,044W/m.K
Elektrolytisch verzinkt/Electro Zingué

Avec boulons à tête Phillips M6 (jusqu'à 076), avec boulon hexagonal M8 (à partir de 089), M12 (à partir de 219)
Plage de température: -50/+105 °C
Matériau isolant : Épaisseur : 30 mm.

Mousse PUR (80 kg/m³). Enveloppe extérieure supplémentaire du film acoustique

HD	Artikel Référence	L mm	A mm	g mm	↔	kg/st kg/ pc	D mm	Max. bel. kN Max. char. kN	M1	h mm	Con. type con.	Iso. d. G Ép. G	Iso. L B Lo. B	Stock	Eenh. Unité
-	BUKTH.015P30	130	26	2,50		0,380	15	1.4	M8	17.5	D	30	50	1	st/pc
-	BUKTH.018P30	130	26	2,50		0,390	18	1.4	M8	17.5	D	30	50	1	st/pc
-	BUKTH.022P30	136	26	2,50		0,430	22	1.4	M8	17.5	D	30	50	1	st/pc
-	BUKTH.028P30	149	26	2,50		0,500	28	1.4	M8	17.5	D	30	50	1	st/pc
-	BUKTH.035P30	145	26	2,50		0,550	35	1.4	M8	17.5	D	30	50	1	st/pc
-	BUKTH.042P30	155	26	2,50		0,610	42.4	2.2	M8/M10	17.5	D	30	50	1	st/pc
-	BUKTH.048P30	170	26	2,50		0,680	48.3	1.8	M8	17.5	D	30	50	1	st/pc
-	BUKTH.054P30	167	26	2,50		0,720	54	1.8	M8	17.5	D	30	50	1	st/pc
-	BUKTH.057P30	167	26	2,50		0,750	57	2.2	M8/M10	17.5	D	30	50	1	st/pc
-	BUKTH.060P30	176	26	2,50		0,790	60.3	1.8	M8	17.5	D	30	50	1	st/pc
-	BUKTH.064P30	183	26	2,50		0,830	64	1.8	M8	17.5	D	30	50	1	st/pc
-	BUKTH.076P30	194	26	2,50		0,930	76.1	1.8	M8	17.5	D	30	75	1	st/pc
-	BUKTH.089P30	220	35	3,00		1,290	88.9	2.1	M8	25.0	D	30	75	1	st/pc
-	BUKTH.108P30	235	35	3,00		1,440	108	2.2	M8/M10	25.0	D	30	75	1	st/pc
-	BUKTH.114P30	236	35	3,00		1,510	114.3	2.1	M8	25.0	D	30	75	1	st/pc
-	BUKTH.133P30	284	35	3,00		1,730	133	3.9	M10/M12	25.0	C	30	100	1	st/pc
-	BUKTH.140P30	284	35	3,00		1,830	139.7	3.9	M10/M12	25.0	C	30	100	1	st/pc
-	BUKTH.159P30	305	35	3,00		2,020	159	3.9	M12/M16	26.0	C	30	100	1	st/pc
-	BUKTH.168P30	305	35	3,00		2,090	168.3	3.9	M12/M16	26.0	C	30	100	1	st/pc
-	BUKTH.219P30	376	35	4,00		2,054	219	4.5	M12/M16	26.0	C	30	100	1	st/pc
-	BUKTH.273P30	428	35	4,00		2,391	273	4.5	M12/M16	26.0	C	30	100	1	st/pc



BUKTH.P50

Thermische isolatieklem PX-50 / Collier d'isol. therm. PX-50

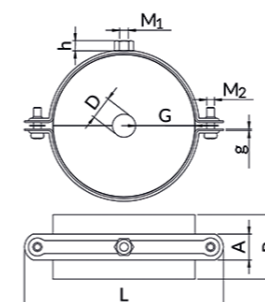

Thermal cond. Coëff. 0,044W/m.K

Stand. Uitv./Exec. Std.

Met kruiskopbouten M6 (tot 042), met zeskantbout M8 (vanaf 048), M12 (vanaf 219)
Temperatuurbereik: -50/+105 °C
Isolatiemateriaal: Dikte: 50mm.

PUR schuim (80kg/m³). Extra buitenschil van akoestische film.

Cond. thermique Coeff. 0,044W/m.K

Elektrolytisch verzinkt/Electro Zingué

Avec boulons à tête Phillips M6 (jusqu'à 076), avec boulon hexagonal M8 (à partir de 089), M12 (à partir de 219)
Plage de température : -50/+105 °C
Matériau isolant : Épaisseur : 30 mm.

Mousse PUR (80 kg/m³). Enveloppe extérieure supplémentaire du film acoustique

HD	Artikel Référence	L mm	A mm	g mm	↔	kg/st kg/ pc	D mm	Max. bel. kN Max. char. kN	M1	h mm	Con. type con.	Iso. d. G Ép. G	Iso. L B Lo. B	Stock	Eenh. Unité
-	BUKTH.015P50	167	26	2,50		1,070	15	1.8	M10/M12	17.5	B	50	50	1	st/pc
-	BUKTH.018P50	167	26	2,50		1,090	18	1.8	M10/M12	17.5	B	50	50	1	st/pc
-	BUKTH.022P50	176	26	2,50		1,160	22	1.8	M10/M12	17.5	B	50	50	1	st/pc
-	BUKTH.028P50	183	26	2,50		1,250	28	2.2	M10/M12	17.5	B	50	50	1	st/pc
-	BUKTH.035P50	194	26	2,50		1,350	35	1.8	M10/M12	17.5	B	50	50	1	st/pc
-	BUKTH.042P50	194	26	2,50		1,460	42.4	2.1	M10/M12	17.5	B	50	50	1	st/pc
-	BUKTH.048P50	220	35	3,00		1,770	48.3	2.1	M10/M12	25.0	D	50	50	1	st/pc
-	BUKTH.054P50	220	35	3,00		1,850	54	2.2	M10/M12	25.0	D	50	50	1	st/pc
-	BUKTH.057P50	220	35	3,00		1,890	57	2.1	M10/M12	25.0	D	50	50	1	st/pc
-	BUKTH.060P50	235	35	3,00		1,930	60.3	2.1	M10/M12	25.0	D	50	50	1	st/pc
-	BUKTH.064P50	235	35	3,00		1,980	64	2.1	M10/M12	25.0	D	50	50	1	st/pc
-	BUKTH.076P50	236	35	3,00		2,160	76.1	2.2	M10/M12	25.0	D	50	75	1	st/pc
-	BUKTH.089P50	252	35	3,00		2,400	88.9	3.9	M10/M12	25.0	C	50	75	1	st/pc
-	BUKTH.108P50	286	35	3,00		2,710	108	3.9	M10/M12	25.0	C	50	75	1	st/pc
-	BUKTH.114P50	300	35	3,00		2,810	114.3	3.9	M12/M16	25.0	C	50	75	1	st/pc
-	BUKTH.133P50	302	35	3,00		3,100	133	3.9	M10/M12	25.0	C	50	100	1	st/pc
-	BUKTH.140P50	302	35	3,00		3,190	139.7	3.9	M10/M12	25.0	C	50	100	1	st/pc
-	BUKTH.159P50	334	35	3,00		3,470	159	3.9	M12/M16	25.0	C	50	100	1	st/pc
-	BUKTH.168P50	376	35	4,00		4,090	168.3	4.5	M12/M16	26.0	C	50	100	1	st/pc
-	BUKTH.219P50	420	35	4,00		2,423	0	4.5	M12/M16	26.0	C	50	100	1	st/pc
-	BUKTH.273P50	459	35	4,00		2,785	0	4.5	M12/M16	26.0	C	50	100	1	st/pc
-	BUKTH.324P50	518	35	4,00		3,140	0	4.5	M12/M16	26.0	C	50	100	1	st/pc
-	BUKTH.356P50	545	35	4,00		4,360	0	4.5	M12/M16	26.0	C	50	100	1	st/pc



BULSP

Sprinkler beugel KPL / Collier pour Sprinkler KPL

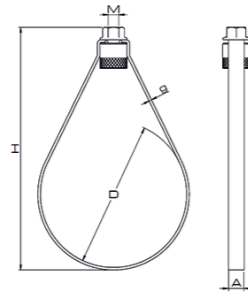

Stand. Uitv./Exec. Std.

Te bestellen per volle verpakking.

Set bevat: beugel, kooimoer en zeskantmoer.
Deze klemmen worden gebruikt voor vaste water sprinklers met FM certificaat.

Elektrolytisch verzinkt/Electro Zingué

A commander par emballage complet.

Kit comprenant : étrier, écrou cage et écrou hexagonal.
Ces pinces sont utilisées pour les sprinklers d'eau fixes avec certificat FM.

HD	Artikel Référence	L mm	A mm	g mm	⇒	kg/st kg/pc	D mm	Max. bel. kN Max. char. kN	M1	h mm	Con. type Type con.	Stock	Eenh. Unité
-	BULSP.033	85	12	1,50		0,077	33-35	4,5	M10		100	X	st/pc
-	BULSP.042	90	12	1,50		0,030	42-45	4,5	M10		100	X	st/pc
-	BULSP.048	100	12	1,50		0,040	48-50	4,5	M10		50	X	st/pc
-	BULSP.058	115	12	1,50		0,100	58-62	4,5	M10		50	X	st/pc
-	BULSP.075	138	15	2,50		0,110	75-78	6,5	M10		50	X	st/pc
-	BULSP.087	160	15	2,50		0,190	87-91	6,5	M10		25	X	st/pc
-	BULSP.110	205	15	2,50		0,191	110-118	6,5	M10		25	X	st/pc
-	BULSP.137	230	15	2,50		0,200	137-147	6,5	M12		20	X	st/pc
-	BULSP.167	272	15	2,50		0,610	167-178	7	M12		20	X	st/pc
-	BULSP.217	353	25	2,50		0,610	217-224	7	M16		10	X	st/pc



BUKSPV

Klem voor sprinklerleiding DN-V / Collier pour sprinkler DN-F

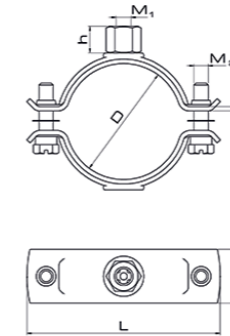
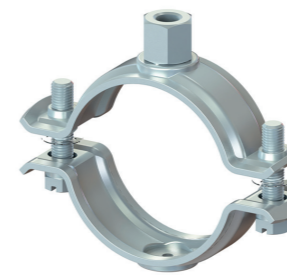

Stand. Uitv./Exec. Std.

Te bestellen per volle verpakking.

Met 2x onverliesbare zeskantbout met gleuf.
Deze klemmen worden gebruikt voor sprinkler en brandblussystemen met VdS certificaat.

Elektrolytisch verzinkt/Electro Zingué

A commander par emballage complet.

Avec 2x boulon hexagonal imperdable à fente.
Ces pinces sont utilisées pour les systèmes de sprinkler et d'extinction d'incendie avec certificat VdS.

HD	Artikel Référence	L mm	A mm	g mm	⇒	kg/st kg/pc	D mm	Max. bel. kN Max. char. kN	M1	h mm	Con. type Type con.	Stock	Cert.	Eenh. Unité
-	BUKSPV.020	66	30	2,50		0,152	20-24	3,1	M8	15	0	50	X	VdS st/pc
-	BUKSPV.025	71	30	2,50		0,161	25-30	3,1	M8	15	0	50	X	VdS st/pc
-	BUKSPV.031	77	30	2,50		0,174	31-35	3,1	M8	15	0	50		VdS st/pc
-	BUKSPV.040	87	30	2,50		0,192	40-45	3,1	M8	15	0	50		VdS st/pc
-	BUKSPV.048	96	30	2,50		0,216	48-53	3,1	M8	15	0	50		VdS st/pc
-	BUKSPV.102	163	30	3,00		0,402	102-108	5,2	M12	18	0	25	X	VdS st/pc
-	BUKSPV.117	179	30	3,00		0,658	117-124	5,2	M12	18	0	10	X	VdS st/pc
-	BUKSPV.133	210	30	3,00		0,834	133-140	5,8	M12	18	0	10	X	VdS st/pc
-	BUKSPV.159	236	40	4,00		0,929	159-165	6,9	M16	24	0	10	X	VdS st/pc



BUKSPFM

Klem voor sprinklerleiding DN-F / Collier pour sprinkler DN-F

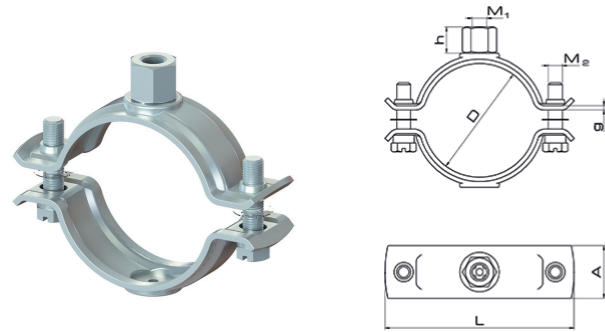

Stand. Uitv./Exec. Std.

Te bestellen per volle verpakking.

Met 2x onverliesbare zeskantbout met gleuf.
Deze klemmen worden gebruikt voor sprinkler en brandblussystemen met FM certificaat.

Elektrolytisch verzinkt/Electro Zingué

A commander par emballage complet.

Avec 2x boulon hexagonal imperdable à fente.
Ces pinces sont utilisées pour les systèmes de sprinkler et d'extinction d'incendie avec certificat FM.

HD	Artikel Référence	L mm	A mm	g mm	↔	kg/st kg/ pc	D mm	Max. bel. kN Max. char. kN	M1	h mm	Con. type Type con.	Stock	Cert.	Eenh. Unité	
-	BUKSPFM.025	71	30	2,50		0,161	25-30	3,1	M10	15		50	X	FM	st/pc
	BUKSPFM.031	76.8	30	2.50		0.174	31-35	3.1	M10	15		50		FM+VdS	st/pc
	BUKSPFM.040	87.5	30	2.50		0.185	40-45	3.1	M10	15		50		FM+VdS	st/pc
	BUKSPFM.048	95.8	30	2.50		0.199	40-46	3.1	M10	15		50		FM+VdS	st/pc
-	BUKSPFM.060	108	30	2,50		0,223	60-65	3,1	M10	15		25		FM+VdS	st/pc
-	BUKSPFM.076	135	30	3,00		0,312	76-81	4,5	M10	15		25		FM+VdS	st/pc
-	BUKSPFM.088	147	30	3,00		0,364	88-93	4,5	M10	15		25	X	FM+VdS	st/pc
-	BUKSPFM.110	171	30	3,00		0,632	110-116	5,2	M12	18		25	X	FM+VdS	st/pc
-	BUKSPFM.140	218	40	4,00		0,770	140-148	5,8	M12	18		10	X	FM+VdS	st/pc
-	BUKSPFM.167	244	40	4,00		0,960	167-173	6,9	M16	24		10	X	FM+VdS	st/pc
-	BUKSPFM.219	296	40	4,00		1,165	219-225	8,2	M16	24		10	X	FM	st/pc



BUKZD

Buisklem zware last PST / Collier robuste PST

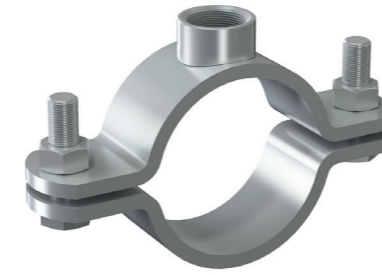

Stand. Uitv./Exec. Std.

Met 2x zeskantbout
Inleg op aanvraag.

Elektrolytisch verzinkt/Electro Zingué

Avec 2 boulons hexagonaux
Insert sur demande.

HD	Artikel Référence	L mm	A mm	g mm	↔	kg/st kg/ pc	D mm	Max. bel. kN Max. char. kN	M1	h mm	Con. type Type con.	Stock	Eenh. Unité
-	BUKZD.020	108	40	6,00		0,440	20-25		M20	16		1	st/pc
-	BUKZD.025	114	40	6,00		0,420	25-29		M20	16		1	st/pc
-	BUKZD.032	122	40	6,00		0,490	32-37		M20	16		1	st/pc
-	BUKZD.040	132	40	6,00		0,560	40-45		M20	16		1	st/pc
-	BUKZD.047	139	40	6,00		0,600	47-52		M20	16		1	st/pc
-	BUKZD.053	123	40	6,00		0,650	53-55		M20	16		1	st/pc
-	BUKZD.057	150	40	6,00		0,680	57-63		M20	16		1	st/pc
-	BUKZD.063	132	40	6,00		0,690	63-65		M20	16		1	st/pc
-	BUKZD.067	161	40	6,00		0,720	67-73		M20	16		1	st/pc
-	BUKZD.075	167	40	6,00		0,780	75-79		M20	16		1	st/pc
-	BUKZD.088	180	40	6,00		0,870	88-92		M20	16		1	st/pc
-	BUKZD.108	220	50	6,00		1,430	108-115		M20	16		1	st/pc
-	BUKZD.125	230	50	6,00		1,530	125-127		M20	16		1	st/pc
-	BUKZD.133	247	50	6,00		1,630	133-140		M20	16		1	st/pc
-	BUKZD.158	270	50	8,00		2,300	158-161		M20	16		1	st/pc
-	BUKZD.164	280	50	8,00		2,320	164-170		M20	16		1	st/pc
-	BUKZD.198	310	50	8,00		2,490	198-203		M20	16		1	st/pc
-	BUKZD.215	332	50	8,00		2,570	215-220		M20	16		1	st/pc
-	BUKZD.269	408	60	8,00		3,870	269-274		M20	16		1	st/pc
-	BUKZD.320	458	60	8,00		4,500	320-325		M20	16		1	st/pc
-	BUKZD.352	492	60	8,00		5,070	352-357		M20	16		1	st/pc
-	BUKZD.403	570	70	10,00		5,070	403-408		M20	16		1	st/pc
-	BUKZD.453	620	70	10,00		8,970	453-458		M20	16		1	st/pc
-	BUKZD.504	672	70	10,00		10,170	504-509		M20	16		1	st/pc



BUKZE

Buisklem zware last PST / Collier robuste PST

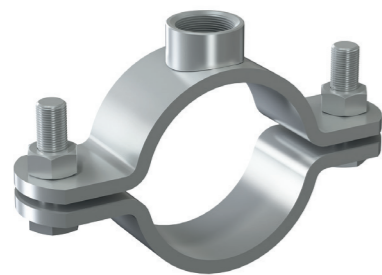

Stand. Uitv./Exec. Std.
Mat. Opt.

Elektrolytisch verzinkt/Electro Zingué
Hot-Dip/Galvanisé à chaud

Met 2x zeskantbout
Inleg op aanvraag.

Avec 2 boulons hexagonaux
Insert sur demande.

HD	Artikel Référence	L mm	A mm	g mm	↔	kg/st kg/pc	D mm	Max. bel. kN Max. char. kN	M1	h mm	Con. type Type con.	Stock	Eenh. Unité
-	BUKZE.020	108	40	6,00		0,440	20-25		1/2"	16	1		st/pc
HD	BUKZE.025	114	40	6,00		0,460	25-29		1/2"	16	1		st/pc
HD	BUKZE.032	122	40	6,00		0,530	32-37		1/2"	16	1		st/pc
HD	BUKZE.040	132	40	6,00		0,630	40-45		3/4"	16	1		st/pc
HD	BUKZE.047	139	40	6,00		0,660	47-52		3/4"	16	1		st/pc
-	BUKZE.053	123	40	6,00		0,680	53-55		3/4"	16	1		st/pc
HD	BUKZE.057	150	40	6,00		0,710	57-63		3/4"	16	1		st/pc
-	BUKZE.063	132	40	6,00		0,720	63-65		3/4"	16	1		st/pc
-	BUKZE.067	161	40	6,00		0,750	67-73		3/4"	16	1		st/pc
HD	BUKZE.075	167	40	6,00		0,810	75-79		3/4"	16	1		st/pc
HD	BUKZE.088	180	40	6,00		0,900	88-92		3/4"	16	1		st/pc
HD	BUKZE.108	220	50	6,00		1,460	108-115		3/4"	16	1		st/pc
-	BUKZE.125	230	50	6,00		1,560	125-127		3/4"	16	1		st/pc
HD	BUKZE.133	247	50	6,00		1,660	133-140		3/4"	16	1		st/pc
HD	BUKZE.158	270	50	8,00		2,330	158-161		3/4"	16	1		st/pc
HD	BUKZE.164	280	50	8,00		2,350	164-170		3/4"	16	1		st/pc
-	BUKZE.198	310	50	8,00		2,520	198-203		3/4"	16	1		st/pc
HD	BUKZE.215	332	50	8,00		2,600	215-220		3/4"	16	1		st/pc
HD	BUKZE.269	408	60	8,00		3,900	269-274		3/4"	16	1		st/pc
HD	BUKZE.320	458	60	8,00		4,500	320-325		3/4"	16	1		st/pc
HD	BUKZE.352	492	60	8,00		5,100	352-357		3/4"	16	1		st/pc
HD	BUKZE.403	570	70	10,00		8,500	403-408		3/4"	16	1		st/pc
-	BUKZE.453	620	70	10,00		9,000	453-458		3/4"	16	1		st/pc
HD	BUKZE.504	672	70	10,00		10,200	504-509		3/4"	16	1		st/pc



BUKZQ

Buisklem zware last PSF / Collier robuste PSF

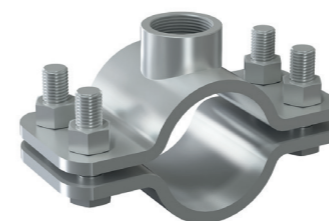

Stand. Uitv./Exec. Std.
Mat. Opt.

Elektrolytisch verzinkt/Electro Zingué
Hot-Dip/Galvanisé à chaud

Met 4x zeskantbout
Inleg op aanvraag.

Avec 4 boulons hexagonaux
Insert sur demande.

HD	Artikel Référence	L mm	A mm	g mm	↔	kg/st kg/pc	D mm	Max. bel. kN Max. char. kN	M1	h mm	Con. type Type con.	Stock	Eenh. Unité
HD	BUKZQ.020	126	90	6,00		1,500	20-25		1 1/4"	23	1		st/pc
HD	BUKZQ.025	135	90	6,00		1,690	25-29		1 1/4"	23	1		st/pc
HD	BUKZQ.032	142	90	6,00		1,780	32-37		1 1/4"	23	1		st/pc
HD	BUKZQ.040	151	90	6,00		1,870	40-45		1 1/4"	23	1		st/pc
HD	BUKZQ.047	157	90	6,00		1,980	47-52		1 1/4"	23	1		st/pc
HD	BUKZQ.057	170	90	6,00		2,080	57-63		1 1/4"	23	1		st/pc
-	BUKZQ.067	179	90	6,00		2,660	67-73		1 1/4"	23	1		st/pc
HD	BUKZQ.075	197	90	8,00		2,960	75-79		1 1/4"	23	1		st/pc
HD	BUKZQ.088	210	90	8,00		3,220	88-92		1 1/4"	23	1		st/pc
HD	BUKZQ.108	234	90	8,00		3,520	108-115		1 1/4"	23	1		st/pc
HD	BUKZQ.125	252	90	8,00		3,780	125-127		1 1/4"	23	1		st/pc
HD	BUKZQ.133	264	90	8,00		4,020	133-140		1 1/4"	23	1		st/pc
HD	BUKZQ.158	290	90	8,00		4,330	158-161		1 1/4"	23	1		st/pc
HD	BUKZQ.164	276	90	8,00		4,530	164-170		1 1/4"	23	1		st/pc
-	BUKZQ.198	332	90	8,00		5,090	198-203		1 1/4"	23	1		st/pc
HD	BUKZQ.215	352	90	8,00		5,360	215-220		1 1/4"	23	1		st/pc
HD	BUKZQ.269	405	90	8,00		6,350	269-274		1 1/4"	23	1		st/pc
HD	BUKZQ.320	442	90	8,00		7,370	320-325		1 1/4"	23	1		st/pc
HD	BUKZQ.352	476	90	8,00		7,960	352-357		1 1/4"	23	1		st/pc
HD	BUKZQ.403	542	90	8,00		9,020	403-408		1 1/4"	23	1		st/pc
-	BUKZQ.453	592	90	8,00		9,900	453-458		1 1/4"	23	1		st/pc
HD	BUKZQ.504	644	90	8,00		10,810	504-509		1 1/4"	23	1		st/pc



BUKZR

Buisklem zware last PSF / Collier robuste PSF

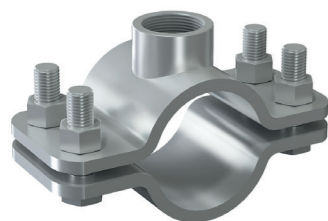

Stand. Uitv./Exec. Std.	Elektrolytisch verzinkt/Electro Zingué
Mat. Opt.	Hot-Dip/Galvanisé à chaud
Met 4x zeskantbout Inleg op aanvraag.	Avec 4 boulons hexagonaux Insert sur demande.

HD	Artikel Référence	L mm	A mm	g	↔	kg/st kg/ pc	D mm	Max. bel. kN Max. char. kN	M1	h mm	Con. type Type con.	Stock	Eenh. Unité
HD	BUKZR.020	126	90	6,00		1,500	20-25		1 1/4"	23	1		st/pc
HD	BUKZR.025	135	90	6,00		1,690	25-29		1 1/4"	23	1		st/pc
-	BUKZR.032	142	90	6,00		1,780	32-37		1 1/4"	23	1		st/pc
HD	BUKZR.040	151	90	6,00		1,870	40-45		1 1/4"	23	1		st/pc
HD	BUKZR.047	157	90	6,00		1,980	47-52		1 1/4"	23	1		st/pc
HD	BUKZR.057	170	90	6,00		2,080	57-63		1 1/4"	23	1		st/pc
-	BUKZR.067	179	90	6,00		2,660	67-73		1 1/4"	23	1		st/pc
HD	BUKZR.075	197	90	8,00		2,960	75-79		1 1/4"	23	1		st/pc
HD	BUKZR.088	210	90	8,00		3,220	88-92		1 1/4"	23	1		st/pc
HD	BUKZR.108	234	90	8,00		3,520	108-115		1 1/4"	23	1		st/pc
HD	BUKZR.125	252	90	8,00		3,780	125-127		1 1/4"	23	1		st/pc
HD	BUKZR.133	264	90	8,00		4,020	133-140		1 1/4"	23	1		st/pc
HD	BUKZR.158	290	90	8,00		4,330	158-161		1 1/4"	23	1		st/pc
HD	BUKZR.164	276	90	8,00		4,530	164-170		1 1/4"	23	1		st/pc
HD	BUKZR.215	352	90	8,00		5,360	215-220		1 1/4"	23	1		st/pc
HD	BUKZR.269	405	90	8,00		6,350	269-274		1 1/4"	23	1		st/pc
HD	BUKZR.320	442	90	8,00		7,370	320-325		1 1/4"	23	1		st/pc
HD	BUKZR.352	476	90	8,00		7,960	352-357		1 1/4"	23	1		st/pc
HD	BUKZR.403	542	90	8,00		9,020	403-408		1 1/4"	23	1		st/pc
-	BUKZR.453	592	90	8,00		9,900	453-458		1 1/4"	23	1		st/pc
HD	BUKZR.504	644	90	8,00		10,810	504-509		1 1/4"	23	1		st/pc



XPBUKDU

Buisklem DUO / Collier DUO

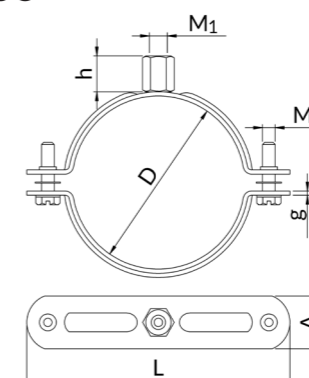
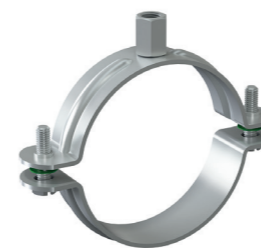

Te bestellen per volle verpakking.

A commander par emballage complet.

HD	Artikel Référence	L mm	A mm	g	↔	kg/st kg/ pc	D mm	Max. bel. kN Max. char. kN	M1	h mm	Con. type Type con.	Stock	Eenh. Unité
-	XPBUKDU.033	76	20	1,25		0,052	33-37	1.2	M8/M10	17	D	50	st/pc
-	XPBUKDU.039	83	20	1,25		0,056	39-44	1.2	M8/M10	17	D	50	st/pc
-	XPBUKDU.045	88	20	1,25		0,059	45-49	1.2	M8/M10	17	D	50	st/pc
-	XPBUKDU.050	93	20	1,25		0,059	50-54	1.2	M8/M10	17	D	25	st/pc
-	XPBUKDU.060	105	20	1,25		0,068	60-65	1.2	M8/M10	17	D	25	st/pc
-	XPBUKDU.072	118	20	1,50		0,089	72-78	1.6	M8/M10	17	D	25	st/pc
-	XPBUKDU.085	132	20	1,80		0,113	85-91	1.6	M8/M10	17	D	25	st/pc
-	XPBUKDU.099	146	25	2,00		0,166	99-105	2.2	M8/M10	17	D	25	st/pc
-	XPBUKDU.106	154	25	2,00		0,174	106-113	2.2	M8/M10	17	D	25	st/pc
-	XPBUKDU.114	162	25	2,00		0,183	114-122	2.2	M8/M10	17	D	25	st/pc
-	XPBUKDU.123	171	25	2,00		0,197	123-131	2.2	M8/M10	17	D	25	st/pc
-	XPBUKDU.132	180	25	2,00		0,206	132-140	2.2	M8/M10	17	D	25	st/pc
-	XPBUKDU.149	200	25	2,50		0,280	149-157	2.2	M8/M10	17	D	10	st/pc
-	XPBUKDU.158	209	25	2,50		0,284	158-167	2.2	M8/M10	17	D	10	st/pc
-	XPBUKDU.168	218	25	2,50		0,302	168-177	2.2	M8/M10	17	D	10	st/pc



XPBUKDU.R

Buisklem DUO met inleg / Collier iso DUO

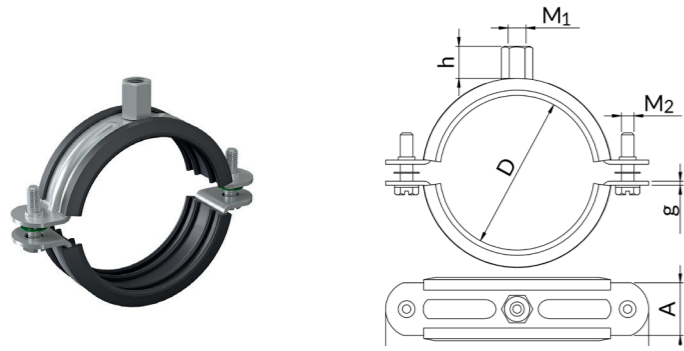

Te bestellen per volle verpakking.

A commander par emballage complet.

HD	Artikel Référence	L mm	A mm	g mm	↔	kg/st kg/ pc	D mm	Max. bel. kN Max. char. kN	M1	h mm	Con. type Type con.	Stock	Eenh. Unité
-	XPBUKDU.026R	76	20	1,25		0,066	26-30	0.9	M8/M10	17	D	100	st/pc
-	XPBUKDU.031R	83	20	1,25		0,075	31-36	0.9	M8/M10	17	D	50	st/pc
-	XPBUKDU.041R	93	20	1,25		0,085	41-46	0.9	M8/M10	17	D	50	st/pc
-	XPBUKDU.047R	103	20	1,00		0,089	47-52	0.9	M8/M10	17	D	50	st/pc
-	XPBUKDU.059R	116	20	2,00		0,104	59-64	0.9	M8/M10	17	D	50	st/pc
-	XPBUKDU.065R	118	20	2,00		0,165	65-71	1.4	M8/M10	17	D	25	st/pc
-	XPBUKDU.072R	125	20	2,00		0,176	72-78	1.4	M8/M10	17	D	25	st/pc
-	XPBUKDU.079R	132	20	2,00		0,188	79-85	1.4	M8/M10	17	D	25	st/pc
-	XPBUKDU.086R	139	25	2,00		0,202	86-92	1.4	M8/M10	17	D	25	st/pc
-	XPBUKDU.093R	146	25	2,00		0,214	93-99	1.4	M8/M10	17	D	25	st/pc
-	XPBUKDU.100R	154	25	2,00		0,223	100-107	1.4	M8/M10	17	D	25	st/pc
-	XPBUKDU.108R	162	25	2,00		0,247	108-115	1.8	M8/M10	17	D	25	st/pc
-	XPBUKDU.116R	171	25	2,00		0,259	116-124	1.8	M8/M10	17	D	25	st/pc
-	XPBUKDU.125R	180	25	2,00		0,265	125-133	1.8	M8/M10	17	D	25	st/pc
-	XPBUKDU.133R	191	25	3,00		0,325	133-141	2.1	M8/M10	17	D	20	st/pc
-	XPBUKDU.142R	200	25	3,00		0,346	142-150	2.1	M8/M10	17	D	10	st/pc
-	XPBUKDU.151R	209	25	3,00		0,357	151-160	2.1	M8/M10	17	D	10	st/pc
-	XPBUKDU.160R	218	25	3,00		0,376	160-169	2.1	M8/M10	17	D	10	st/pc
-	XPBUKDU.200R	258	25	2,50		0,454	200-210	2.1	M8/M10	17	D	10	st/pc



BPFW

Basisplaat voor draadbuis Wirtworth BIW / Support Witworth BIW

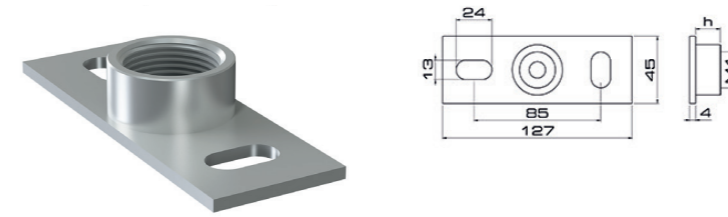

Stand. Uitv./Exec. Std.

Elektrolytisch verzinkt/Electro Zingué

Te gebruiken met TIW.

À utiliser avec TIW.

HD	Artikel Référence	L mm	A mm	g mm	↔	kg/st kg/ pc	D mm	Max. bel. kN Max. char. kN	M1	h mm	Con. type Type con.	Stock	Eenh. Unité
-	BPFW100	127	45	1"		0,200						1	st/pc
-	BPFW050	127	45	1/2"		0,200						1	st/pc
-	BPFW075	127	45	3/4"		0,210						1	st/pc

BPFM

Basisplaat voor draadbuis / Support

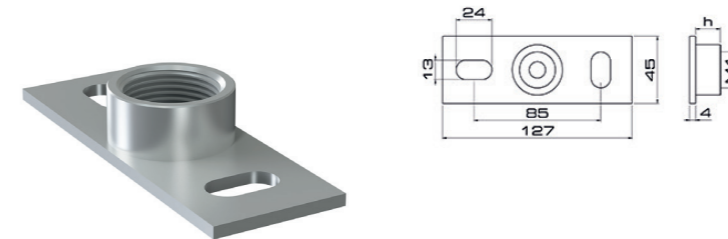

Stand. Uitv./Exec. Std.

Elektrolytisch verzinkt/Electro Zingué

Te gebruiken met TIM.

À utiliser avec TIM.

HD	Artikel Référence	L mm	A mm	g mm	↔	kg/st kg/ pc	D mm	Max. bel. kN Max. char. kN	M1	h mm	Con. type Type con.	Stock	Eenh. Unité
-	BPFM16	127	45	M16		0,220						1	st/pc
-	BPFM20	127	45	M20		0,230						1	st/pc



BPLM

Basisplaat voor draadstang / Plaque de base à tige filetée

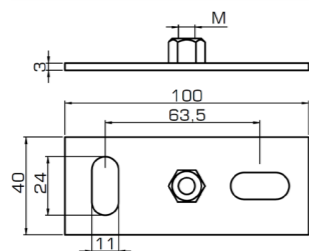
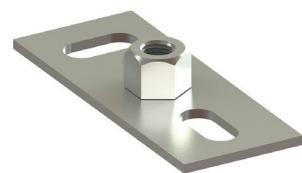

Stand. Uitv./Exec. Std.

Elektrolytisch verzinkt/Electro Zingué

Te gebruiken met TIM.

À utiliser avec TIM.

HD	Artikel Référence	L mm	A mm	g mm	⇔ kg/st kg/ pc	D mm	Max. bel. kN Max. char. kN	M1	h mm	Con. type Type con.	Stock	Eenh. Unité
-	BPLM8	100	40	3,00	0,090						10	st/pc
-	BPLM1012	100	40	3,00	0,100						10	st/pc
-	BPLM12	100	40	3,00	0,130						10	st/pc

TIW

Draadstang Withworth BIW / Tige filetée Withworth BIW



Stand. Uitv./Exec. Std.

Elektrolytisch verzinkt/Electro Zingué

HD	Artikel Référence	L mm	A mm	g mm	⇔ kg/st kg/ pc	D mm	Max. bel. kN Max. char. kN	M1	h mm	Con. type Type con.	Stock	Eenh. Unité
-	TIW050	2000	-	1/2"	1,660						1	st/pc
-	TIW075	2000	-	3/4"	2,760						1	st/pc
-	TIW100	2000	-	1"	3,940						1	st/pc
-	TIW125	2000	-	1-1/4"	5,420						1	st/pc



UB

U-bout / Boulon en U

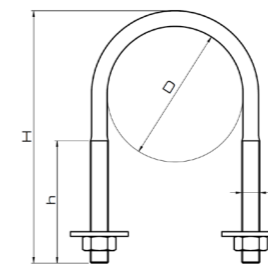

Stand. Uitv./Exec. Std.

Elektrolytisch verzinkt/Electro Zingué

Te bestellen per volle verpakking.

A commander par emballage complet.

HD	Artikel Référence	H mm	D mm	M	⇔ kg/st kg/ pc	D mm	Max. bel. kN Max. char. kN	M1	h mm	Con. type Type con.	Stock	Eenh. Unité
-	UB021M8	75	37	M8	0,070						100	st/pc
-	UB027M8	80	43	M8	0,070						100	st/pc
-	UB034M10	105	54	M10	0,140						1	st/pc
-	UB034M8	87	50	M8	0,080						100	st/pc
-	UB042M10	115	62	M10	0,150						1	st/pc
-	UB042M8	95	58	M8	0,090						100	st/pc
-	UB048M10	120	68	M10	0,170						50	st/pc
-	UB048M8	100	64	M8	0,090						100	st/pc
-	UB060M10	130	80	M10	0,180						50	st/pc
-	UB060M8	110	76	M8	0,100						50	st/pc
-	UB076M10	147	96	M10	0,190						25	st/pc
-	UB076M8	125	92	M8	0,100						1	st/pc
-	UB089M10	162	109	M10	0,210						25	st/pc
-	UB114M10	184	134	M10	0,240						10	st/pc
-	UB114M8	165	130	M8	0,120						25	st/pc
-	UB139M12	240	163	M12	0,420						1	st/pc
-	UB168M10	238	188	M10	0,300						10	st/pc
-	UB168M12	352	192	M12	0,610						1	st/pc
-	UB200M12	280	224	M12	0,520						1	st/pc
-	UB219M12	300	243	M12	0,560						1	st/pc
-	UB250M12	340	276	M12	0,600						1	st/pc
-	UB273M12	355	297	M12	0,660						1	st/pc
-	UB324M12	395	348	M12	0,740						1	st/pc



VRM

Verloopstuk zeskant M/V / Raccords de réduction hex M/F

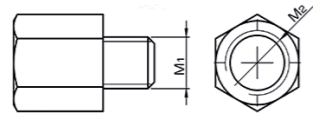
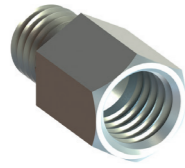

Stand. Uitv./Exec. Std.

Te bestellen per volle verpakking.

Elektrolytisch verzinkt/Electro Zingué

A commander par emballage complet.

HD	Artikel Référence	L mm	A mm	g mm	⇔	kg/st kg/ pc	D mm	Max. bel. kN Max. char. kN	M1	h mm	Con. type Type con.	Stock	Eenh. Unité
-	VRM08M06					0,010					25	st/pc	
-	VRM06M08					0,010					25	st/pc	
-	VRM08M10					0,010					25	st/pc	
-	VRM10M08					0,020					20	st/pc	
-	VRM10M12					0,020					25	st/pc	
-	VRM10M16					0,060					5	st/pc	
-	VRM10W025					0,050					5	st/pc	
-	VRM12M08					0,018					25	st/pc	
-	VRM12M16					0,060					5	st/pc	
-	VRM12W025					0,050					5	st/pc	
-	VRM16W025					0,100					5	st/pc	



VMM

Draadstangmoffen zeskant / Raccords de connexion hexagonales F/F

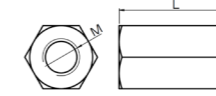
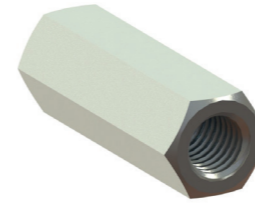

Stand. Uitv./Exec. Std.

Te bestellen per volle verpakking.

Elektrolytisch verzinkt/Electro Zingué

A commander par emballage complet.

HD	Artikel Référence	L mm	A mm	g mm	⇔	kg/st kg/ pc	D mm	Max. bel. kN Max. char. kN	M1	h mm	Con. type Type con.	Stock	Eenh. Unité
-	VMM16	42				0,100						10	st/pc
-	VMM20	48				0,130						10	st/pc

PNK

Glijmoer met PVC houder / Erou couissant avec support PVC

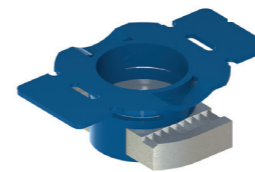

Stand. Uitv./Exec. Std.

Te bestellen per volle verpakking.

Elektrolytisch verzinkt/Electro Zingué

A commander par emballage complet.

HD	Artikel Référence	L mm	A mm	g mm	⇔	kg/st kg/ pc	Stock	Eenh. Unité
-	PNK08	50	34	6,00		0,020	50	st/pc
-	PNK10	50	34	6,00		0,020	50	st/pc
-	PNK12	50	34	8,00		0,030	25	st/pc



PNM

Glijmoer met metalen klemplaat / Ecrou coulissant avec plaque de serrage métallique

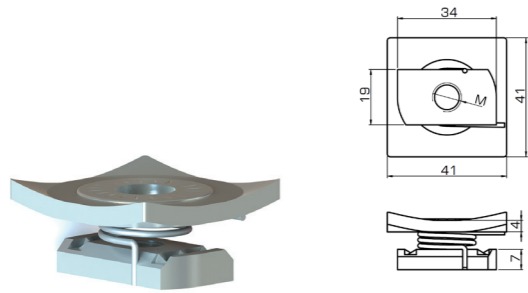

Stand. Uitv./Exec. Std.

Elektrolytisch verzinkt/Electro Zingué

Te bestellen per volle verpakking.

A commander par emballage complet.

HD	Artikel Référence	L mm	A mm	g mm	⇔	kg/st kg/ pc	⊠	Stock	Eenh. Unité
-	PNM08	41	41	20,00		0,070	25		st/pc
-	PNM10	41	41	20,00		0,070	25		st/pc
-	PNM12	41	41	20,00		0,070	20		st/pc

I4PNK

Glijmoer met PVC houder / Ecrou coulissant avec support en PVC

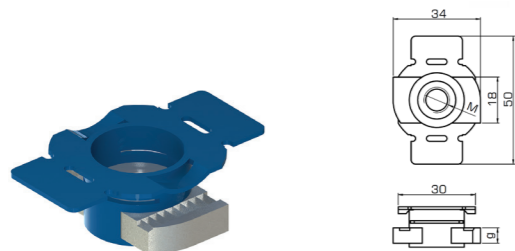

Stand. Uitv./Exec. Std.

Inox 304/Acier Inoxydable 304

Te bestellen per volle verpakking.

A commander par emballage complet.

HD	Artikel Référence	L mm	A mm	g mm	⇔	kg/st kg/ pc	⊠	Stock	Eenh. Unité
-	I4PNK08	50	34	6,00		0,020	50		st/pc
-	I4PNK10	50	34	6,00		0,020	50		st/pc
-	I4PNK12	50	34	8,00		0,030	25		st/pc



I4BPLM

Basisplaat voor draadstang / Plaque de base pour tige filetée

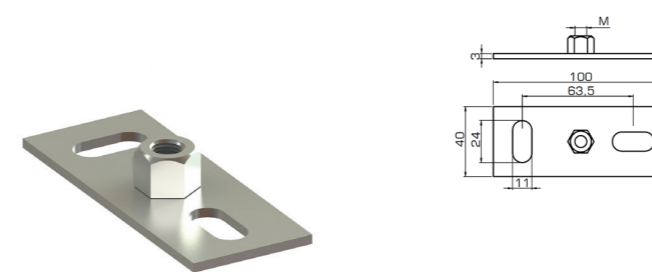

Stand. Uitv./Exec. Std.

Inox 304/Acier Inoxydable 304

Te bestellen per volle verpakking.

A commander par emballage complet.

HD	Artikel Référence	L mm	A mm	g mm	⇔	kg/st kg/ pc	D mm	Max. bel. kN Max. char. kN	M1	h mm	Con. type Type con.	⊠	Stock	Eenh. Unité
-	I4BPLM8	100	40	3,00		0,090						10		st/pc
-	I4BPLM10	100	40	3,00		0,100						10		st/pc
-	I4BPLM12	100	40	3,00		0,130						1		st/pc
-	I4BPFM20	127	45	4,00		0,230						1		st/pc

I4SDBGM

Steeledek beugel / Cintre de trapèze

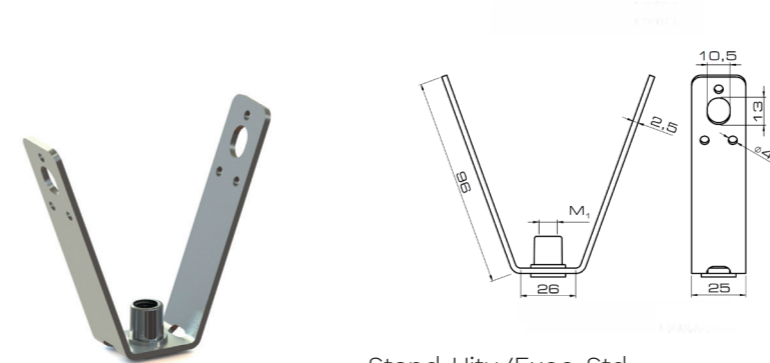

Stand. Uitv./Exec. Std.

Inox 304/Acier Inoxydable 304

Te bestellen per volle verpakking.

A commander par emballage complet.

HD	Artikel Référence	L mm	A mm	g mm	⇔	kg/st kg/ pc	D mm	Max. bel. kN Max. char. kN	M1	h mm	Con. type Type con.	⊠	Stock	Eenh. Unité
-	I4SDBGM8	100	40	3,00		0,100						50		st/pc
-	I4SDBGM10	100	40	3,00		0,110						50		st/pc



Allied Tube & Conduit ▲ AFC Cable Systems ▲ Heritage Plastics ▲ Unistrut
Unistrut Construction ▲ Cope ▲ US Tray ▲ Calbrite ▲ Calbond ▲ Kaf-Tech
Columbia-MBF ▲ Eastern Wire + Conduit ▲ ACS/Uni-Fab ▲ Cii
Power-Strut ▲ Calconduit ▲ Razor Ribbon ▲ Calpipe Security
FRE Composites ▲ Vergokan ▲ Flexicon ▲ Marco

Atkore
Vergokan NV
Meersbloem-Melden 16
9700 Oudenaarde
België/Belgique
T. +32 55 31 83 35

VergokanSales@atkore.com - VergokanExport@atkore.com

www.atkore.com/vergokan